

COATS®

5060 A/E
5060 AX/EX

Rim Clamp®

Tire Changer

*For servicing single piece
automotive and most light
truck tire/wheel assemblies*

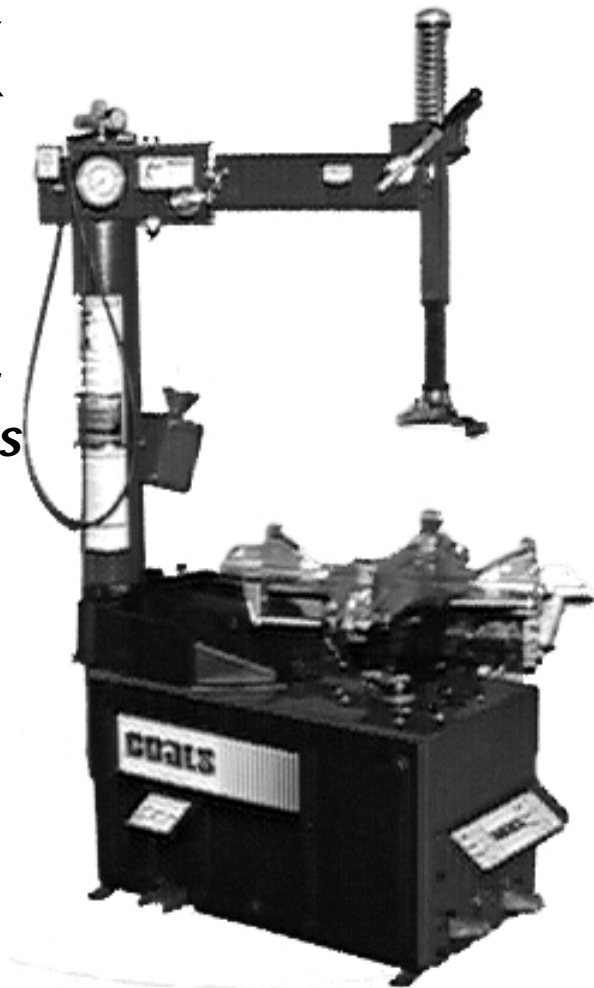

**Safety Instructions
Operating Instructions
Installation Instructions
Maintenance Instructions**

READ these instructions before placing unit in service. KEEP these and other materials delivered with the unit in a binder near the machine for ease of reference by supervisors and operators.

HENNESSY INDUSTRIES, INC.

1601 J. P. Hennessy Drive, LaVergne, TN USA 37086-3565 615/641-7533 800/688-6359

HENNESSY INDUSTRIES INC. Manufacturer of AMMCO®, COATS® and BADA® Automotive Service Equipment and Tools.

Manual Part No.: 8182883 01

Revision: 12/96

Table of Contents

Definitions of Hazard Levels	1
Owner's Responsibility	1
Principal Operating Parts	2
Operating Instructions	3
Bead Loosening and Demounting	3
Mounting	6
Inflation	7
Bead Sealing	7
Bead Seating	8
Inflation	8
Performance, Custom, and Aluminum Wheels ..	9
Aluminum and Custom Wheels	9
Performance Tires and Wheels • Demounting ..	9
Performance Tires and Wheels • Mounting	11
Custom and Special Wheels	12
Tube Type Tires	12
Stages of Inflation	13
Bead Seal	13
Bead Seat	13
Inflation	13
Mis-Matched Tires and Wheels	13
Maintenance Instructions	14
Installation Instructions	15
Critical Safety Instructions	Back Cover



Operator Protective Equipment



Personal protective equipment helps make tire changing safer. However, equipment does not take the place of safe operating practices. Always wear durable work clothing during tire service activity. Shop aprons or shop coats may also be worn, however loose fitting clothing should be avoided. Tight fitting leather gloves are recommended to protect operator's hands when handling worn tires and wheels. Sturdy leather work shoes with steel toes and oil resistant soles should be used by tire service personnel to help prevent injury in typical shop activities. Eye protection is essential during tire service activity. Safety glasses with side shields, goggles, or face shields are acceptable. Back belts provide support during lifting activities and are also helpful in providing operator protection. Consideration should also be given to the use of hearing protection if tire service activity is performed in an enclosed area, or if noise levels are high.



WARNING

Failure to follow danger, warning, and caution instructions may lead to serious personal injury or death to operator or bystander or damage to property. Do not operate this machine until you read and understand all the dangers, warnings and cautions in this manual. For additional copies of either, or further information, contact:

Hennessy Industries, Inc.
P.O. Box 3002, 1601 J.P. Hennessy Drive
LaVergne, TN 37086-1982
(615) 641-7533 or (800) 688-6359

Important Addresses

RUBBER MANUFACTURERS ASSOCIATION
1400 K Street N.W.
Washington, DC 20005

TIRE GUIDES, INC.
The Tire Information Center
1101-6 South Rogers Circle
Boca Raton, FL 33487-2795

Definitions of Hazard Levels

Identify the hazard levels used in this manual with the following definitions and signal words:

DANGER

Watch for this symbol:



It Means: Immediate hazards which will result in severe personal injury or death.

WARNING

Watch for this symbol:



It Means: Hazards or unsafe practices which could result in severe personal injury or death.

CAUTION

Watch for this symbol:





It Means: Hazards or unsafe practices which may result in minor personal injury or product or property damage.

 Watch for this symbol! It means **BE ALERT!** Your safety, or the safety of others, is involved!

Owner's Responsibility

To maintain machine and user safety, the responsibility of the owner is to read and follow these instructions:

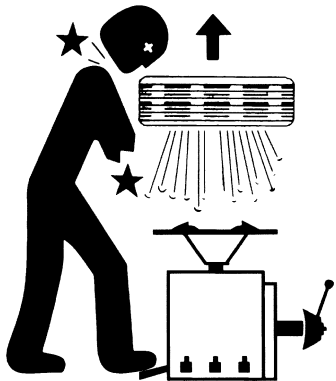
- Follow all installation instructions.
- Make sure installation conforms to all applicable Local, State, and Federal Codes, Rules, and Regulations; such as State and Federal OSHA Regulations and Electrical Codes.
- Carefully check the unit for correct initial function.
- Read and follow the safety instructions. Keep them readily available for machine operators.
- Make certain all operators are properly trained, know how to safely and correctly operate the unit, and are properly supervised.
- Allow unit operation only with all parts in place and operating safely.
- Carefully inspect the unit on a regular basis and perform all maintenance as required.
- Service and maintain the unit only with authorized or approved replacement parts.
- Keep all instructions permanently with the unit and all decals on the unit clean and visible.

 DANGER Explosion Hazard Never exceed 40 PSI while seating beads.		 DANGER Explosion Hazard Never inflate tire above manufacturer's recommended pressure after bead is seated.
---	--	---

Principal Operating Parts

Know Your Unit

Compare this illustration with the unit before placing it into service. Maximum performance and safety will be obtained only when all persons using the unit are fully trained in its parts and operation. Each user should learn the function and location of all controls. Prevent accidents and injuries by ensuring the unit is properly installed, operated, and maintained.



Do It Now

Now is a good time to fill out the Owner's Registry Card.

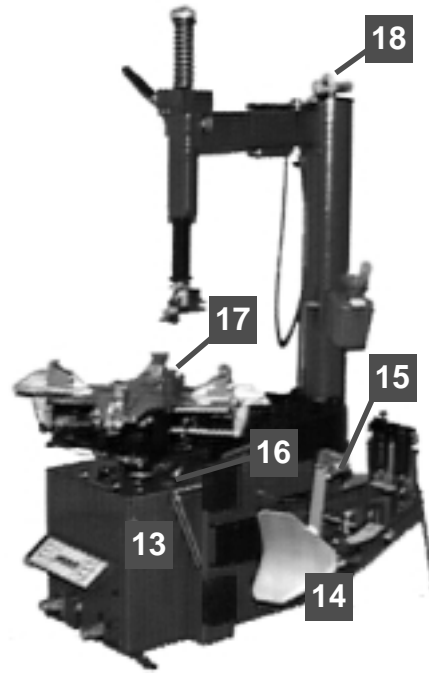
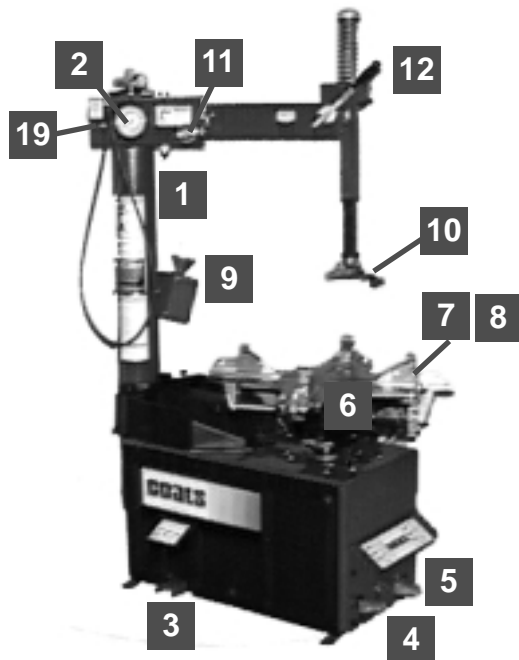

- 1 Tower** — Support for horizontal and vertical slides, also air storage tank.
- 2 Air Inflation Gauge** — Registers tire pressure when clip-on chuck is attached to valve stem and inflation pedal is released.
- 3 Inflation Pedal** — Three position pedal that allows inflation of tires through air hose and clip-on chuck.
- 4 Clamp Control Pedal** — Three position pedal that opens and closes rim clamps.
- 5 Table Top Pedal** — Three position pedal that controls rotation of table top.
- 6 Table Top** — Rotating chuck for tire changing.
- 7 Clamps** — Secures wheel to table top for tire changing.
- 8 Adjustable Clamp (AX/EX)** — Adjusts outward to allow outside clamping of wheels up to 21".
- 9 Lube Bottle** — Dispenser for rubber lubricant.
- 10 Combination Mount/Demount Head** — Mounts and demounts tire from wheel.

- 11 Swing Arm Adjustment Knob** — Adjusts swing arm/vertical slide assembly for proper horizontal positioning of mount/demount head.
- 12 Vertical Slide Locking Handle** — Locks and unlocks vertical slide and sets correct vertical position to maintain head/wheel clearance.
- 13 Bead Lifting Tool** — Used to lift and position tire bead correctly on mount/demount head.
- 14 Bead Loosener Shoe** — Pivoting shoe for loosening tire beads.
- 15 Bead Loosener Handle/Button** — Controls operation of bead loosener shoe.
- 16 Oil Check Dipstick** — For transmission oil level.
- 17 Bead Sealing Nozzles** — Expands tire sidewall to bead seat area of rim to seal and allow inflation.
- 18 Pressure Safety Valve** — The high pressure safety valve is set to exhaust at line pressures above 185 PSI.
- 19 Release Valve** — Allows the manual release of air pressure from tire.

OPERATING INSTRUCTIONS

The unit must be properly operated and properly maintained to help avoid accidents that could damage the unit and injure the operator or bystanders. This section of the Operating Instructions manual review basic operations and use of controls. These instructions should be reviewed with all employees before they are allowed to work with the machine. Keep these instructions near the machine for easy reference.

BEAD LOOSENING AND DEMOUNTING



CAUTION This machine may operate differently from machines you have previously operated. Practice with a regular steel wheel and tire combination to familiarize yourself with the machine's operation and function.

A. Remember to remove all weights from both sides of the wheel. Weights left on back side of wheel may cause the wheel to be clamped unlevel. This may result in the combination mount/demount head contacting the rim causing scratches. On alloy wheels, always rotate the wheel one turn after setting the head to insure proper wheel chucking.

B. Always review nicks and scratches with owners of expensive wheel and tire combinations prior to servicing.

C. Review the performance wheel section of this manual prior to servicing performance tire/wheel combinations.

1. Deflate tire completely by removing the valve core from the valve stem (Figure 1).



Figure 1 – Remove Valve Core to Deflate Tire

NOTE: Loosening the beads on a partially or fully inflated tire is unsafe and causes excess movement and friction against the bumper pads and excessive wear on pivots. Deflate the tire completely to prolong the life of your machine.

D. Always loosen the bead on the narrow side of the wheel's drop center first. See Figure 4 for more information on the drop center.

E. The clamps on the table top may extend beyond the table top itself. To avoid damaging the clamps, move them to their full inward position before positioning a tire for bead loosening.

F. Use extra care in positioning the bead loosener shoe on larger wheels/tires, and on alloy wheels. Make sure the shoe rests next to but not on the rim, and not on the tire sidewall.

2. Pull the bead loosener shoe away from the machine and roll wheel into position. The valve stem should be in the 3 o'clock position. Position the bead loosener shoe against the tire next to, but not on, the rim. Press the button on the bead loosener to actuate the shoe and loosen the bead. It may be necessary to loosen the bead in multiple locations around the tire



(Figure 2).

Figure 2 – Position Tire and Bead Loosener Shoe

3. Turn wheel around and repeat loosening procedure on the other side of the wheel. This should be the long side of the drop center (see Figure 4).

G. It will be easier to clamp the wheel to the table top if the lower bead is loosened last.



- Apply tire manufacturer's approved rubber lubricant liberally to entire circumference of both tire beads after loosening (Figure 3).

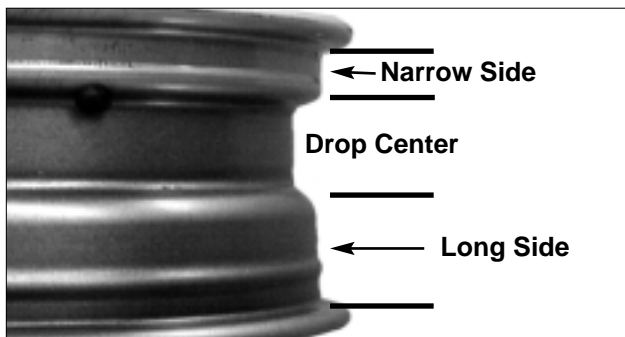

Figure 3 – Apply Rubber Lubricant to Tire Beads

- Determine the mounting side of the wheel. The mounting side is the narrow side of the drop center. (Tire removed in Figure 4 for clarity.)

Figure 4 – Determining Mounting Side of Wheel

- Place tire/wheel assembly on table top with mounting side up (Figure 5). Use the clamp control pedal to move the clamps inwards (push pedal down) or outwards (toggle pedal up).



Clamp steel wheels from the inside (clamps push outwards against wheel). Clamp mag and custom wheels from the outside (clamps push inwards against the outside rim edge). Refer to the Performance Tires and Wheels section.

Figure 5 – Place Tire/Wheel Assembly on Table Top

- Move the swing arm into position. Pull the locking handle forward to release the slide.



Push down on the top of the vertical slide to

move the demount head into contact with the rim edge. Push the locking handle back to lock the slide into place. As the slide is locked, the mount/demount head will move upward

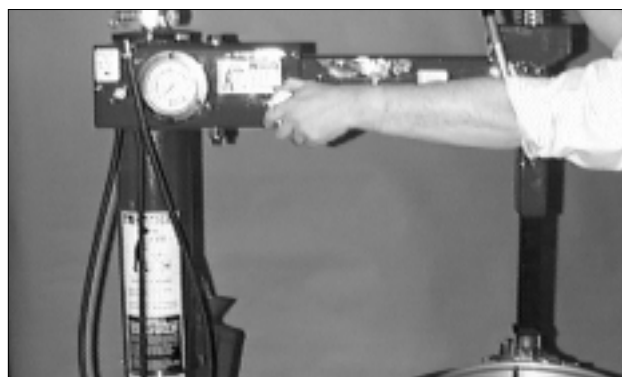

approximately 1/8 inch from rim edge (Figure 6).

Figure 6 - Position Mount/Demount Tool

- The mount/demount head roller should be in contact with the rim edge. Turn the swing arm adjusting knob to move the roller away from the rim 1/8 to 1/4 inch (Figure 7).

Figure 7 - Adjust Swing Arm to Position Head Roller

- Check head positioning. Mount/demount head should be positioned with 1/8 to 3/16" clearance

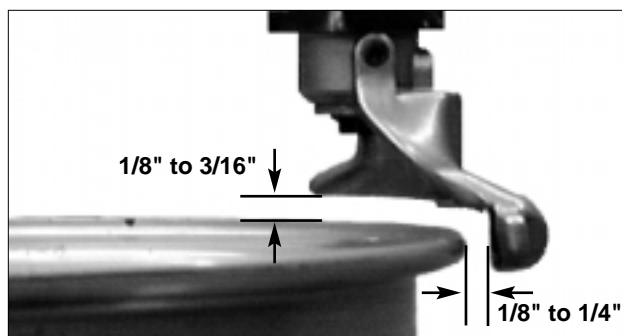

between the top of the rim edge and the bottom of the head, and 1/8 to 1/4 inch clearance between the rim edge and the head roller. This clearance will be maintained as long as the locking handle and adjustment knob are not changed. The operator may swing the arm out of the way and back into place again without needing to reposition the head (when changing a like set of wheels) (Figure 8).

Figure 8 - Proper Mount/Demount Head Position

H. The vertical tool clearance may change with machine use and should be inspected often. Failure to maintain the proper clearance may result in damage to the wheel rim and/or tire.

- Insert the smooth curved end of the bead lifting tool over the forward end of the demount head and below the top bead of the tire. Use your free



hand to press down on the tire opposite the head to help with tool insertion (Figure 9).



Figure 9 - Insert Bead Lifting Tool

11. Push the bead lifting tool down towards the wheel to lift the tire bead up and over the knob portion of the demount head. Hold the tool and bead in this position (Figure 10).

Figure 10 - Lift Bead Over Demount Head

12. Depress the table top pedal to rotate the wheel clockwise. The demount head will guide the upper bead up and over the edge of the wheel.

J. Push down on the tire across from the demount head during table top rotation to utilize the drop center area of the wheel. This reduces the tensional force on the top or first bead



during demount (Figure 9).

13. Lift and hold the tire at an angle so that the lower bead is resting in the drop center directly across from the demount head, and is loose below the demount head (Figure 11). Insert the

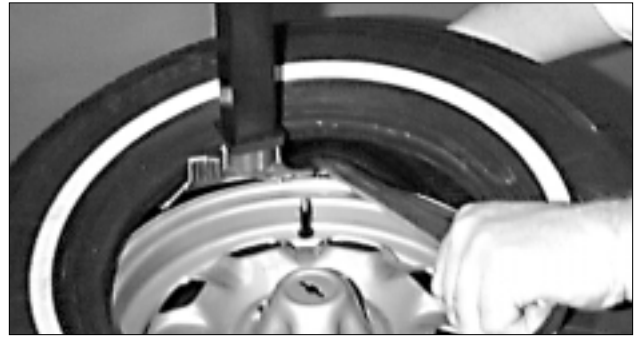

smooth curved end of the bead lifting tool down over the forward end of the mount/demount tool and below the lower bead. Lift the bead up and over the knob on the demount head (Figure 12).

Figure 11 - Demounting Lower Bead

14. Depress the table top pedal to rotate the wheel. The demount head will guide the bead up and over the edge of the wheel. Continue rotation until lower bead is demounted.



CAUTION

Figure 12 - Guide Lower Bead Over Tool Head

K. With tube-type tires, demount the upper bead and remove the tube before demounting the lower bead.

L. Table top rotation can be stopped at any time by removing your foot from the rotation pedal.



M. Normal table top rotation for demounting is clockwise. Depress the table top pedal to rotate this direction. To rotate the table top counterclockwise, lift the pedal up with your toe.

At times during the mounting and demounting procedure, the bead lifting tool may encounter resistance or come under load. Keep one hand firmly on the tool to avoid possible tool disconnect. Use the reversing feature to back out of jam ups.

After successfully completing the demount process, proceed to Mounting (page 6).

MOUNTING

This information must be read and followed carefully to prevent accidents and injuries during mounting.

WARNING Check tire and wheel carefully before mounting. Make sure the tire bead diameter and wheel diameter match exactly. Consult the *Rubber Manufacturer's Association* for approved rim widths for tire sizes.

DANGER Attempts to force a bead seat on mis-matched tires and wheels can cause the tire to violently explode, causing serious personal injury or death to operator and/or bystanders.

CAUTION Never mount a tire and wheel handed to you by anyone without checking both tire and wheel for damage and compatibility. Be extra cautious of persons without knowledge of tire service. Keep bystanders out of service area.

WARNING Never mount a damaged tire. Never mount a tire on a rusty or damaged wheel. Damaged tires and/or wheels may explode.

CAUTION If you damage the tire bead during mounting, STOP!, remove the tire and mark it as damaged. Do not mount a damaged tire.

1. Inspect the wheel closely for damage. Clean the wheel and remove any light corrosion or rubber residue (Figure 13). Do not attempt to service heavily corroded wheels.



Figure 13 - Inspect and Clean the Wheel

2. Inspect tire for damage, paying close attention to the beads. Verify size match between tire and wheel (Figure 13).
3. Lubricate tire beads liberally with tire manufacturer approved lubricant (Figure 14).



Figure 14 - Lubricate Beads

4. Place tire over wheel and move swing arm into position. Position tire so that the lower bead is above the rear extension of the mount/demount head and below the front knob (Figure 15).



Figure 15 - Position Tire Against Mount/Demount Head

5. Depress table top pedal and rotate the wheel to mount the lower bead. Use the drop center of the wheel to reduce the tensional force on the bead by pressing down on the tire directly across from the mount head. Rotate table top until lower bead is fully mounted.



Figure 16 - Mounting Top Bead

6. For top bead, rotate the table top until the valve stem is directly across from the mount head. Lift the upper bead up and over the rear of the mount head. With your left hand press down on the tire between the mount head and the valve stem to hold the tire in the drop center. Depress table top pedal and rotate tire until the bead is mounted. Continue to press down on tire during the remaining mounting process (Figure 16).

WARNING Do not force the tire onto the rim. Bead damage could result making the tire unsafe and/or creating the risk of injury.

N. If table top rotation stalls, reverse the table top momentarily until the tire bead is again loose on the wheel. Reposition the tire on the mount head, make sure the bead is correctly positioned in the drop center of the wheel, then attempt mounting again.

P. For low profile or stiff sidewall tires, it may be advantageous to use the bead lifting tool to initially hold the upper bead down in the drop center, or use drop center tools as shown in Figure 32, page 11.

R. For tube type tires, mount the lower bead first, move swing arm out, install the tube, and then mount the upper bead.

INFLATION

Tire inflation is performed in three steps: Bead Seal, Bead Seat, and Inflation. These steps are explained in detail on page 13. Read the explanation of each step and understand them thoroughly before proceeding.

CAUTION Check for proper inflation gauge operation. Accurate pressure readings are important to safe tire inflation. Refer to the Operating Maintenance section of this manual for instructions.

CAUTION If the rim has been clamped from the outside for tire mounting, release the clamps, lift the tire, and move the clamps to the center of the table top.

CAUTION If the wheel/tire has a diameter larger than 14 inches and is difficult to bead seal, the clamps should be moved to the center of the table top for the bead seal operation.

DANGER Tire failure under pressure is hazardous. This tire changer is not intended to be a safety device to contain exploding tires, tubes, wheels, or bead sealing equipment. Inspect tire and wheel carefully for match, wear, or defects before mounting. Always use approved tire bead lubricant during mounting and inflation.

The inflation pedal, located at the rear of the left side of the machine, controls the flow of air through the inflation hose.

NOTE: The clip-on chuck on the end of the hose should always be an open style with all parts in proper working order.

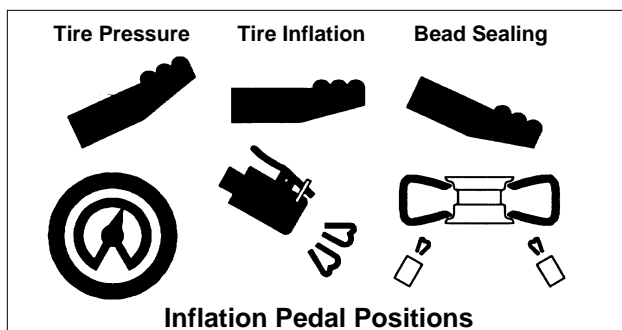

Position 1 - Tire Pressure – With the inflation hose attached to the tire valve and the pedal in this position, the air gauge will register the air pressure in the tire. Whenever your foot is removed from the pedal, it will return to this position.

Position 2 - Tire Inflation – This is the first activated position. With the inflation hose attached to the tire valve and the pedal in this position, line pressure is allowed to flow through the valve and into the tire for inflation. Tire pressure is **not** indicated on the gauge in this position.

Position 3 - Bead Sealing – This is the second and last activated position. With the inflation hose attached to the tire valve and the pedal in this position, line pressure is allowed to flow through the valve and to the air-plate bead seal jets on the table top for bead sealing.

CAUTION Use Position 3 for bead sealing only. Do not use this position without a tire and wheel positioned on the table top. Dirt and debris could be blown into the air with enough force to injure the operator or bystanders. Do not use this position to inflate a tire.

S. The unit is equipped with a pressure limiter to assist the operator with proper tire inflation. When the inflation pedal is held in position 2, the pressure limiter cycles the machine between position 2 (inflation) and position 1 (at rest, no air flow to tire). This cycling helps to prevent over inflation of the tire. Tires can still be over inflated and explode with the use of this pressure limiter if all of the instructions in this manual are not followed completely. The pressure limiter will keep most car and light truck tires from inflating beyond 60 PSI (smaller tires may reach higher pressures). It is the operator's responsibility to follow all instructions and to control inflation pressure as specified in these instructions. Check the function of the pressure limiter regularly and maintain it according to the instructions provided in this manual for safe and proper operation. Do not tamper with or attempt to adjust the pressure limiter. Tires requiring inflation beyond 60 PSI should be inflated in a safety cage.

Bead Sealing

1. Position valve stem in front of operator and connect the inflation hose. Hold tire up against upper edge of the wheel. Be sure tire's top bead is over the bottom of the valve stem (Figure 17).



Figure 17 - Lift Tire Upwards for Bead Sealing

2. Depress inflation pedal to position 2 and hold about 1 second to begin air flow through tire valve, then depress pedal to position 3 and hold briefly – less than 1 full second. The blast of air from the jets will expand tire and seal the beads.
3. Release the inflation pedal and allow it to return to position 1. Verify that both beads are completely sealed to the wheel. Repeat these steps if beads have not sealed. It may be necessary to wait a few seconds for the air storage tank to recover before attempting again.

T. If tire and wheel are properly lubricated and operator cannot achieve bead seal after 3 or 4 attempts, the valve core may be removed from the valve stem to allow more air flow into the tire to assist with bead seal. After bead seal is achieved, remove the chuck and reinstall the valve core.

Bead Seating



WARNING Operator should keep hands, arms, and entire body away from the tire during the remaining bead seat and inflation procedures. Do not stand over tire, as personal injury could result.



WARNING NEVER increase air pressure to exceed 40 PSI when attempting Bead Seat. If operator is unable to obtain Bead Seat, something is wrong. Deflate tire completely, inspect tire and wheel, correct any problems found, relubricate both tire beads, and reattempt Bead Seal and Seat procedures. Follow all safety instructions in this manual and on machine.

1. Once tire pressure is indicated on the air gauge (inflation pedal in position 1; foot removed from pedal), continue to inject air into the tire in short intervals. Check the pressure frequently. Stand back during bead seat. Keep hands, arms, and entire body away from tire during this procedure.

Tire beads should move outward and "pop" into their bead seat position as pressure inside the tire increases. If this does not happen, a problem exists. Investigate carefully.



DANGER Check tire pressure frequently. Never exceed 40 PSI while seating beads. Once seated, never exceed tire manufacturer's recommended air pressure. Tires can explode, especially if they are inflated beyond their limits. At all pressure levels when inflating through the valve stem, keep hands, arms, and entire body away from inflating tire. An exploding tire, wheel, or bead seating equipment may propel upward and outward with sufficient force to cause serious injury or death to operator or bystander.

Inflation



DANGER NEVER exceed tire manufacturer's recommended air pressure. Tires can explode, especially if inflated beyond these limits. Keep hands, arms, and entire body back from inflating tire. Avoid distraction during inflation. Check tire pressure frequently to avoid over inflation. Excessive pressure can cause tires to explode, causing serious injury or death to operator or bystander.

1. Make sure both beads are seated. When both beads are seated, the tire is ready for inflation.
2. Replace the valve core if it was removed.
3. Depress the inflation pedal to position 2 to inflate the tire. The pressure limiter will cycle the air flow as described earlier. On most passenger car tires, the pressure limiter will cease air flow at approximately 60 PSI. On smaller volume tires the pressure may be higher.

U. Release air pressure from tire by pressing the manual release valve button (inflation hose must be attached to the valve stem, Figure 18).

<p>DANGER</p> <p>Explosion Hazard Never exceed 40 PSI while seating beads.</p>		<p>DANGER</p> <p>Explosion Hazard Never inflate tire above manufacturer's recommended pressure after bead is seated.</p>
--	--	--

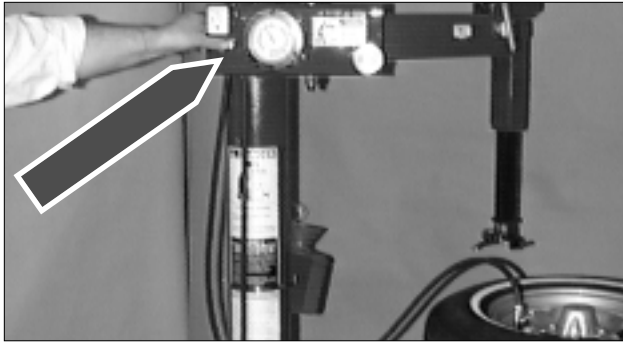

Figure 18 - Location of Manual Release Valve

PERFORMANCE, CUSTOM, AND ALUMINUM WHEELS



CAUTION Only tire technicians with experience and training on custom wheels should attempt to service expensive custom alloy or aluminum wheels and high-performance low-profile tires.

Pre-Operation Notes:

- Ensure all weights have been removed.
- Assistance will be required on wide wheels.
- Clamp wheel from the outside.
- Use ample lubricant for mount and demounting
- Always review wheel nicks and/or scratches with the owner before servicing.

Aluminum and Custom Wheels

Follow instructions provided for standard steel wheels, except:

AA. After loosening and lubricating both beads, rotate the table top until the clamps are in the 12, 3, 6, and 9 o'clock positions.

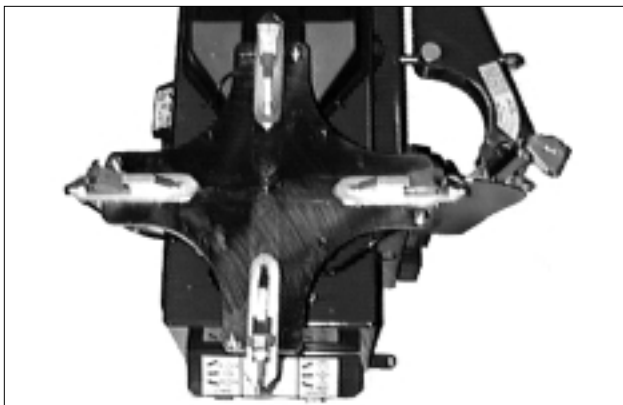

Figure 19 - Rotate Table Top to 12 O'clock

AB. The normal position for all clamps is position 1 (or the most inward position). This provides outside clamping of wheels 10 to 17.5 inches in diameter, and inside clamping of wheels from 12 to 20 inches in diameter

Use position 2 only on large diameter wheels. This provides outside clamping of wheels 14 to 21 inches, and inside clamping of wheels from 16 to 24 inches in diameter.

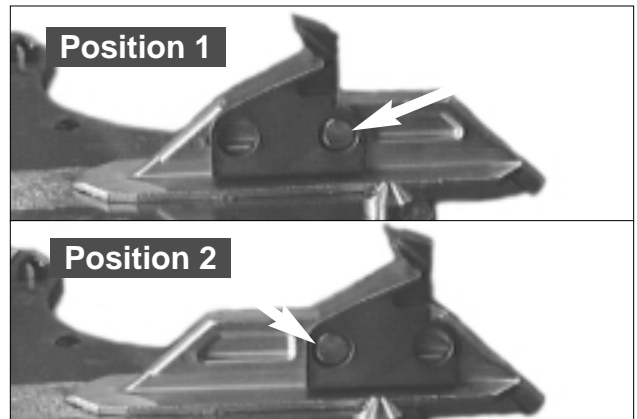

Figure 20 - Adjustable Clamp Positions

AC. Clamp wheel from the outside. Position rim edge into clamp at 12 o'clock position. Lower the wheel and depress the clamp control pedal. Slowly move the clamps inward until they securely contact the outside edge of the rim.

TIP: This is usually accomplished by crouching down in front of the tire changer, holding the wheel with the right hand, and operating the clamp control pedal with the left hand. This allows the operator to watch the clamps as they move to ensure proper, damage-free clamping.

Performance Tires and Wheels • Demounting

Follow these instructions for performance type tires and wheels, including run-flat tires and their associated wheels, and asymmetrical hump wheels.

1. Remove valve core and completely deflate tire.
2. Pull the bead loosener shoe away from the machine and roll the tire into position against the bumper pads. Position the tire with the valve stem in the 3 o'clock position (in direct line with the bead loosener shoe). Reposition the bead loosener positioning pin for wheels over 10 inches wide. Always loosen the bead on the narrow/mounting side of the wheel first (Figures 4 and 21).

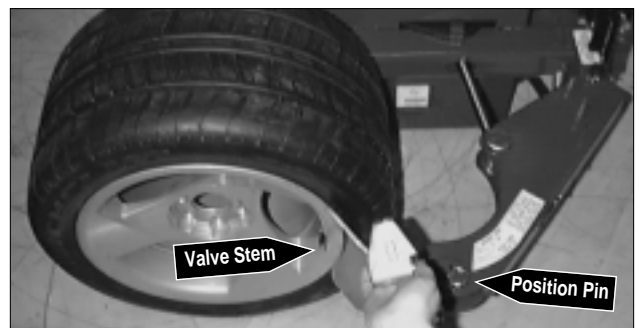

Figure 21 - Position Tire for Bead Loosening and Place Positioning Pin in Proper Location for Wide Wheels

AD: Wheels with an asymmetrical hump have a larger "ledge" type hump around the wheel except at the valve hole making them more difficult to mount and demount (Figure 22).

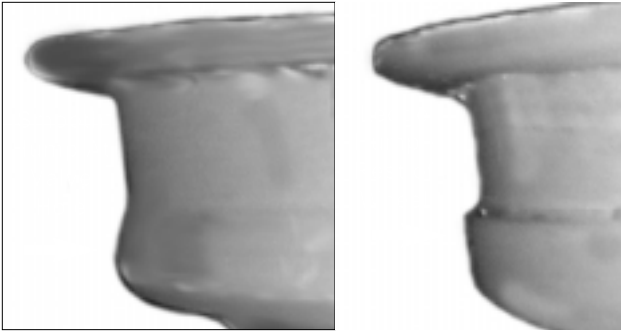

Figure 22 - Asymmetrical Hump Wheel

AE: Some wheels have a low pressure sensor/transmitter strapped to the wheel. This is especially true on run-flat tire/wheel systems. The sensor is positioned directly opposite the valve stem. To avoid damaging the sensor, always loosen the top bead at the valve stem first, then loosen the bottom bead at the valve stem, and then continue to loosen the remaining circumference of the beads as necessary (Figure 23).

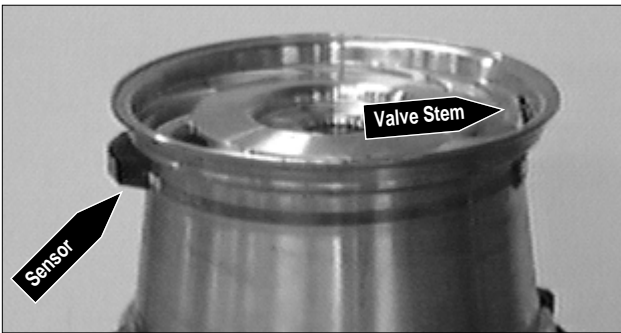

Figure 23 - Wheel with Low Pressure Sensor/Transmitter

3. Loosen bottom bead, starting with valve stem positioned directly next to the loosener shoe (Figure 24).

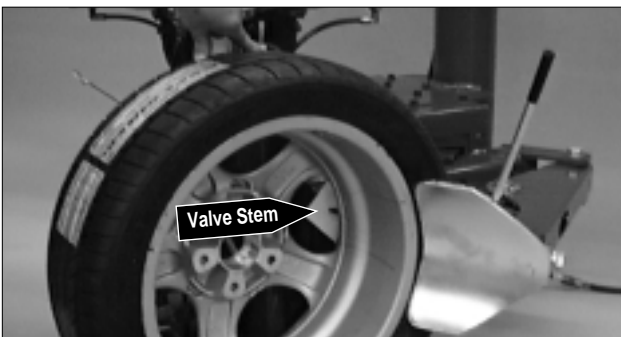

Figure 24 - Loosen Bottom Bead

4. Liberally lubricate the bottom bead of the tire (Figure 25).

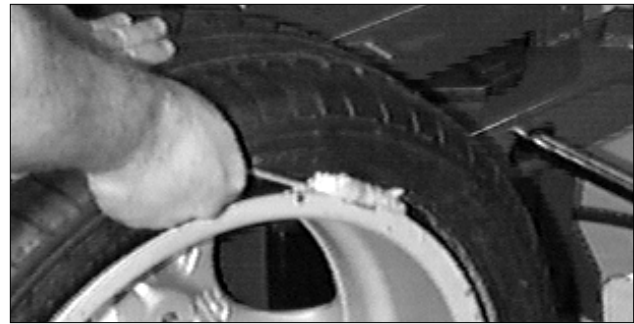

Figure 25 - Lubricate Bottom Bead

5. Clamp the wheel to the table top as described in items AB and AC on page 9. Always clamp custom wheels from the outside.
6. Lubricate upper bead liberally. Use the bead lifting tool to help push the tire bead down so bead area is easier to reach for lubrication (Figure 26).



Figure 26 - Lubricate Upper Bead

7. Move swing arm into place and adjust as described on page 4, steps 7, 8, and 9. Increase the distance between the demount head and the wheel an additional 1/16 to 1/8 inch with the adjustment knob. Locate the valve stem directly under the demount head before proceeding (Figure 27).

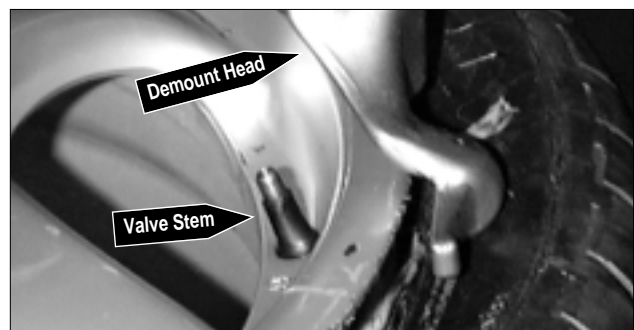

Figure 27 - Position Valve Stem Under Demount Head

8. Insert bead lifting tool between knob on demount tool and tire bead. Pull lifting tool down over wheel to lift bead up and over the knob (Figure 28).

AF: On asymmetrical hump wheels and stiff sidewall performance tires, it may be necessary to use 2 optional drop center tools (part #435685) to hold tire in the drop center so that the bead can be lifted over the demount tool.



Figure 28 - Insert Bead Lifting Tool (Optional Drop Center Tools Shown)

9. Hold lifting tool in place and depress the table top control pedal momentarily to jog the wheel a short distance. Check the wheel and tire to verify that operation is not causing damage.



Figure 29 - Pull Lifting Tool Down and Rotate Wheel

10. The lifting tool can usually be removed after jogging the wheel a short distance. Continue to jog the wheel to allow tire to flex where it crosses the rim edge. Continue short rotations until top bead is completely demounted.



Figure 30 - Remove Drop Center Tools Before Tool Head

11. Demount lower bead. In most cases when demounting performance tires, the lower bead will be less difficult. Use help to lift, position, and hold tire. Pay close attention to sensor/transmitter location, and position it directly below the demount tool when starting the lower bead demount procedure (Figure 31).



Figure 31 - Use Help on Lower Bead, Watch Sensor

Performance Tires and Wheels - Mounting

1. Lubricate both tire beads liberally. Performance tires will require more lubrication than standard passenger car tires.
2. Mount the lower bead. In most cases, the lower bead will mount easily.



Figure 32 - Mount Upper Bead, Use Lifting Tool

3. Position the valve stem directly across from the mount/demount tool for top bead mounting. Lift the top bead over the rear of the mount head. Use the lifting tool to help push and keep the top bead in the drop center during mounting, or use an optional drop center tool to help hold the bead in the drop center (Figures 32 and 33). Rotate the wheel in short steps and apply extra lubricant to mount upper bead.

AG: Mounting the top bead can be very difficult when mounting new tires on performance and custom wheels. Proceed slowly and cautiously.



Figure 33 - Mounting Top Bead

- Mount the top bead using short rotations of the wheel. On stiff sidewall tires, add a second drop center tool to keep the bead in the drop center.



Figure 34- Add Second Drop Center Tool

- On extremely tight tire and wheel combinations, it may be necessary to use the hooked end of the bead lifting tool to flip the tire over the rim flange (Figure 35).

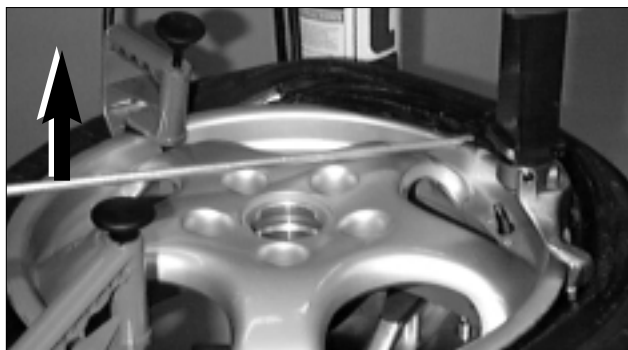

Figure 35 - Use Hooked End of Bead Lifting Tool

- After beads are mounted, unclamp wheel, lift it slightly, and move the clamps to the center of the table top. With the tire/wheel loose on the table top, follow the detailed instructions provided in the Inflation section of this manual for bead sealing, bead seating, and inflation.

CUSTOM AND SPECIAL WHEELS



If a custom wheel is damaged in mounting or dismounting, **STOP**, and avoid damaging the other wheels. Continue only when the cause is identified and corrected.

Alloy Wheels

Some manufacturers offer wheels with little or no drop center. These are not DOT approved. The tire or wheel - or both - can be damaged and the tire could explode under pressure, resulting in serious injury or death. If you attempt to mount/demount this type of wheel, use extreme caution (Figure 36).

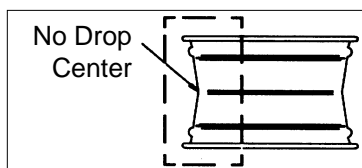
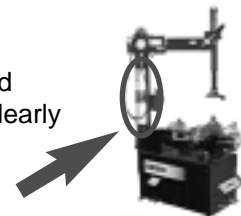

Figure 36 - No Drop Center



Do it Now

Make sure the instruction and warning decal is clean and clearly visible to operator.



European Performance Wheels (Asymmetrical Hump)
Some European wheels have very large humps except near the valve hole. On these wheels, the beads should be loosened at the valve hole on both the upper and lower sides first (Figure 37).

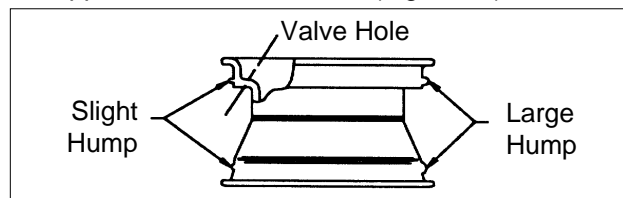

Figure 37 - Asymmetrical Hump on European Wheels

Wheels with Low Pressure Warning Sensors

Performance wheels on some vehicles (including Corvette, BMW, Lamborghini Diablo) have a pressure sensor strapped to the rim opposite the valve hole. On these wheels, the beads should be loosened at the valve hole on both upper and lower sides first (Figure 38).

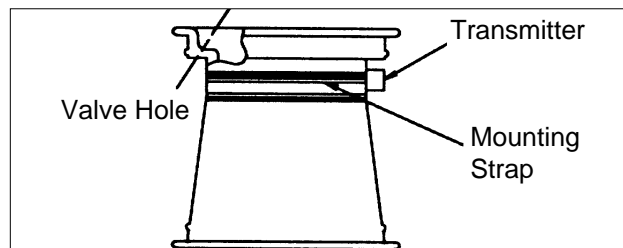

Figure 38 - Wheels with Low Pressure Sensor

TUBE TYPE TIRES

Mounting

- Avoid pinching or forcing the tube.
- Apply rubber lubricant to the beads of the tire.
- Mount the bottom bead.
- Round out the tube with a small amount of air.
- Apply rubber lubricant to the tube.
- Insert the tube into the tire.
- Mount the top bead.

Demounting

- After tire beads are loosened, lubricate the beads and rim liberally.
- Position demount head and bead lifting tool as described in steps 7 through 11 on pages 4 and 5. Depress table top pedal and rotate only a short distance at a time. This allows you to stop the process should the tube get pinched.
- After upper bead is demounted, remove tube and demount lower bead.

STAGES OF INFLATION

Review these descriptions and diagrams carefully. Refer to them as necessary during bead sealing, bead seating, and inflation to verify that you are proceeding properly and safely.

Bead Sealing

A 140 PSI air blast from the table top jets creates an air curtain to aid in bead sealing. Never exceed 10 PSI in the tire during bead sealing. The tire will contain about 1/2 to 2 PSI when bead seal is obtained.

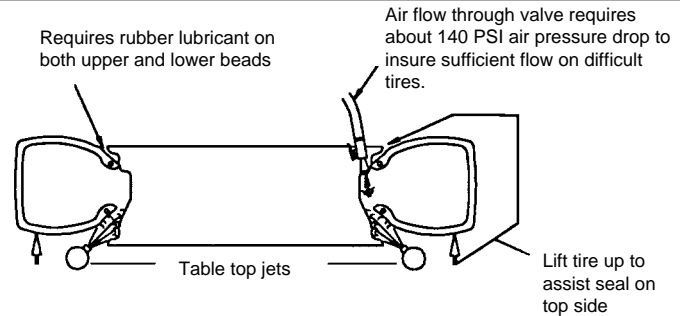

Bead Seating

Bead seating usually occurs on the long tapered side of the wheel first and the shorter side last. Bead seating will usually require at least 7 PSI in the tire. 40 PSI is the maximum safe pressure at this stage regardless of tire operating pressure.

Most European import cars and many aftermarket alloy wheels are very tight and can be difficult to bead seat. Also note that **asymmetrical hump and run-flat tires are extremely difficult to bead seat.** Follow tire manufacturer's recommended procedure for bead seating.

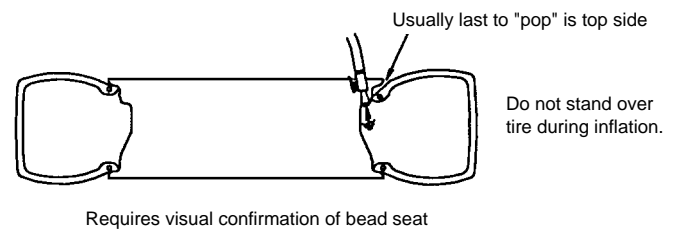

Inflation

After the beads are seated, the tire is inflated. Do not inflate the tire above the manufacturer's recommended pressure as stamped on the tire sidewall. The typical inflation pressure for automobile tires is between 24 and 45 PSI. Light truck inflation pressure typically covers a wider range.

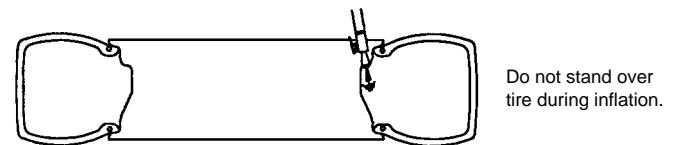

MIS-MATCHED TIRES AND WHEELS

Never attempt to mount and inflate mis-matched tires and wheels.



Mis-matched tire and wheel combinations explode, causing personal injury or death to operator and bystanders.

For safety, do not attempt to mount and inflate mis-matched tires and wheels.

Half Size Tires
14.5, 15.5, 16.5,
17.5, etc.

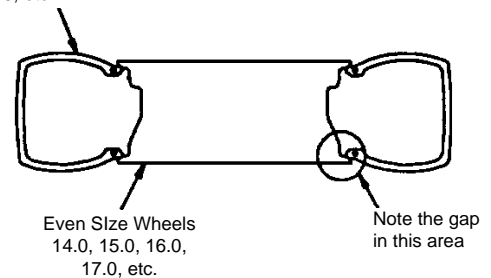

Even Size Tires
14.0, 15.0, 16.0,
17.0, etc.

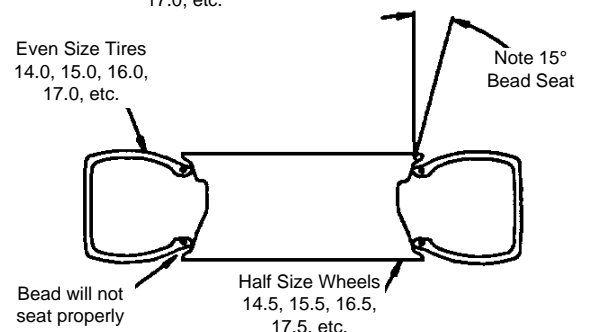

MAINTENANCE INSTRUCTIONS

Read and follow all the maintenance instructions provided in this manual to keep the machine in good operating condition. Refer to the other materials received with the unit and to the service bulletins from the manufacturer for additional instructions on proper maintenance and service. Regular inspections and proper maintenance are essential to preventing accidents and injuries.

WARNING Before making any inspection, adjustment, or repair, disconnect the power source and block out all moving parts to prevent injury.

WARNING Keep the machine and the immediate work area clean. Do not use compressed air to remove dirt and debris from the machine. Foreign material may be propelled into the air and into operator or bystander causing personal injury.

CAUTION Wear protective clothing and use eye protection when making any adjustments or repairs to the machine.

- A. The vertical slide should be cleaned with a vaporizing solvent and then lubricated with chassis grease once a month.
- B. Check the adjustment of the mount/demount head once a month. See instructions this page.
- C. Check the fluid level in the table top transmission once every 3 months. If fluid shows on dipstick, level is satisfactory. If no fluid shows, add an SAE 80 gear lubricant until fluid shows on dipstick.
- D. The table top, clamps, mount/demount head, and other working surfaces should be cleaned with a vaporizing solvent every month.
- E. The clamps should be inspected and metal chips and dirt removed from the serrations with a wire brush once a month.
- F. Check the tire pressure gauge function daily, and check the accuracy monthly. Use a pressurized tire and a high quality stick-type pressure gauge. If necessary, adjust the dial of the machine gauge. If the gauge is defective, replace it immediately (part number 107985). Contact COATS at (615) 641-7533. Check function of the pressure limiter weekly. Always reinstall the lens after adjusting the gauge.
- G. Make sure all fasteners are securely tightened.

- H. Make certain that all guards and covers are in place.
- I. Check for worn, damaged or missing parts including grips and protective covers. Replace them before allowing the unit to be used.
- J. On a daily basis, inspect the unit and check to be certain that all systems are operating normally. Detailed inspection and testing procedures are specified for various components at regular intervals. Set up a chart and assign responsibility for these items.

CAUTION Replace any damaged or missing safety decals. They are available from COATS, (615) 641-7533.

IMPORTANT: These instructions will help you service the unit. Instructions are for a person with some mechanical ability and training. No attempt has been made to describe all basic steps. For example, how to loosen or tighten fasteners. Also basic procedures such as cycling systems and checking operation of the equipment are not fully described since they are known to anyone who does mechanical and service work. Do not attempt to perform work beyond your ability or at which you have no experience. If you need assistance, call an authorized service center or contact COATS directly.

Mount/Demount Tool Head Adjustment

To Adjust Tool Head Lift

Loosen jam nut (ref. 1) and adjust screw (ref. 2) until lift clearance is 1/8" to 3/16". Tighten jam nut and check.

To Adjust Lock Tightness

With lock handle unlocked, loosen jam nut (ref. 3) and adjust pin (ref. 4) until a slight firmness is obtained, then tighten jam nut and check. Also recheck tool head lift at this time.

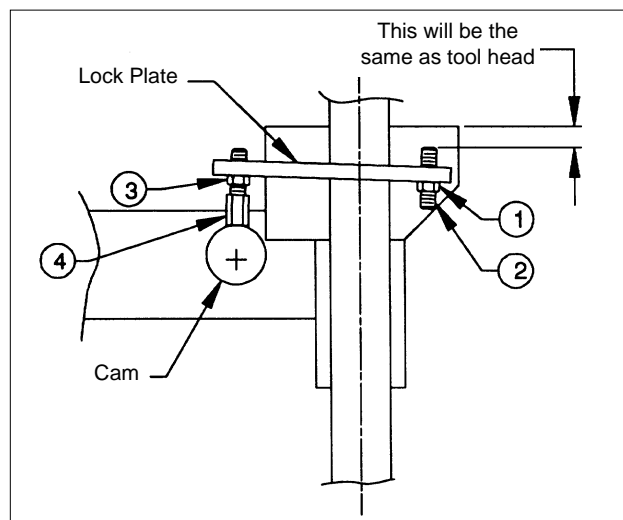

Separator/Lubricator Maintenance

Check oil and water levels regularly, and perform these maintenance items weekly:

- A. Disconnect air supply to machine.
- B. Drain water from the separator by unscrewing the petcock on the bottom of bowl. Allow water to drain and tighten petcock securely by hand.
- C. Add oil to the lubricator if the fluid level is more than 1/4" from the top of the gauge. Remove the filler plug on top of the lubricator and add SAE 10W non-detergent oil or an air tool oil to bring the level up to 1/4" from the top of the gauge. Replace filler plug and clean up any spilled oil.
- D. Adjust the oil flow by pulling the red flow adjustment ring up and turning it to increase or decrease the flow. Push the ring down to lock. Watch the formation of oil drops in the see-through oil chamber. Reconnect the air supply and continually cycle the bead loosener through full strokes and count the drips during the cycles. The delivery of oil to the air line should be about 1 drop per 10 cylinder cycles. Adjust flow as required.

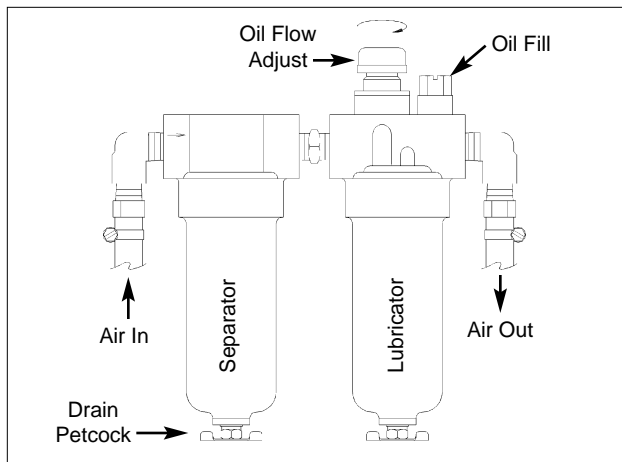

Mount/Demount Head Cleaning

Clean dirt and debris from the mount/demount tool (duckhead) roller with small screw driver or pick.



Pressure Limiter Maintenance

The pressure limiter helps prevent inflation of standard size of larger tires or tubes beyond 60 PSI to minimize risk of explosion. This device is for the safety of the operator and bystanders. Proper operation of the pressure limiter is essential to safe operation of the machine.

Check operation of the pressure limiter as shown and described below at least monthly:

1. Remove tires and/or wheels from the machine.
2. Connect the inflation hose to an empty service tank with a pressure gauge (gauge should read 0). Use a tank with a 250 PSI pressure rating.
3. Depress inflation pedal to position 1 to start air flow through the hose and into the tank. Maintain a steady pressure for constant flow.
4. Watch the rising pressure on the tank gauge and the gauge on the machine. Machine gauge should cycle between check and inflation pressures while tank gauge climbs steadily. As tank pressure reaches 60 PSI, the pressure limiter should stop the air flow automatically. Both gauges should read 60 PSI \pm 5 PSI.
5. Release inflation pedal. Check manual release valve function by pressing the button and releasing pressure from the tank until it reaches 50 PSI. Disconnect inflation hose, and release air inside tank.
6. Replace pressure limiter if it fails to cycle properly during inflation, if it fails to shut air supply off at 60 PSI, or if it malfunctions in any other way. Do not operate machine with a faulty pressure limiter.

⚠ DANGER Operating a tire changer with a defective, improperly adjusted, or by-passed pressure limiter could cause an operator to accidentally over-pressurize a tire, resulting in a tire explosion with severe injury or death to the operator or bystanders. Always be sure that the pressure limiter is present and is operating properly on the machine at all times.

⚠ DANGER Never inflate tire above manufacturer's recommended pressure after bead is seated. Pressure limiter is set at 60 PSI. Any required inflation above 60 PSI should be performed in an inflation chamber/safety cage or securely mounted on the vehicle if an inflation chamber is not available. A tire explosion may cause personal injury or death to operator or bystanders may occur.

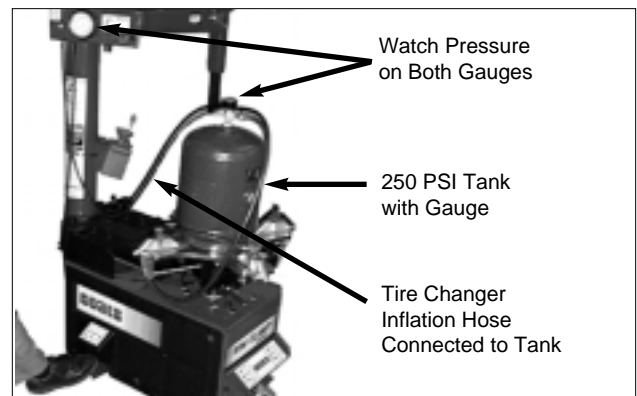

INSTALLATION INSTRUCTIONS



Proper unit installation is necessary for safe use and efficient operation.

Proper installation also helps protect the unit from damage and makes service easier. Always place safety poster and instructions near the unit.

Location

Select a location using the drawings below. The area should provide the operator with enough space to use the equipment in a safe manner. The area selected should be well lit, easy to clean and should be away from oil, grease, brake lathe chips, etc. Avoid areas where bystanders and customers may be present.

Workspace Requirements

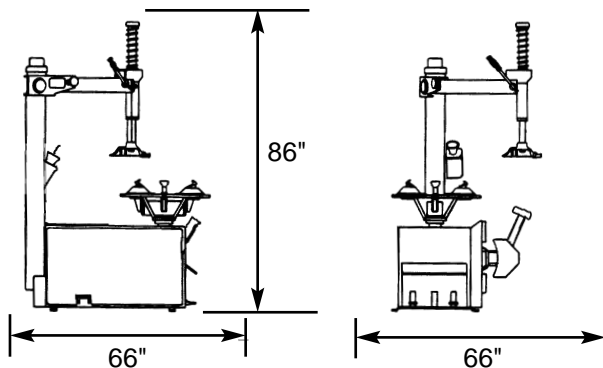

Air Source

The 5060A/AX all-air models require a 14 to 15 CFM air source at 150 PSI. The 5060E/EX air/electric models require a 5 CFM air source at 150 PSI. The safe operating pressure range for all models is between 110 PSI and 175 PSI at the machine.

The unit is furnished with a 1/4" pipe thread male fitting for easy connection. This connection is located on the right side of the rear of the machine. A 1/4" ID hose (or pipe) for connection to the machine is satisfactory. Sufficient air pressure assures good performance.

Electrical Source

The 5060E/EX models require power from a 15 amp electrical circuit. Refer to the serial tag located on the lower part of the machine for specific electrical requirements for the unit. Have a licensed electrical technician perform any necessary changes to the power source before plugging in the unit. The electrical source must have a solid connection (less than 1 ohm) between ground and building ground.

Floor Mounting

The machine should be securely bolted to the floor with suitable anchors using the hole at each corner of the machine base.

Notes

ONE WORD FOR SAFETY

R.I.M.

READ INSPECT MOUNT

READ...

Mounting and inflating the wrong size tire can get you hurt. *Read* the size on the tire and make sure it matches the rim. Be especially careful about putting a smaller tire on a larger rim, such as a 16-inch tire on a 16.5-inch rim.

Inflation of a mismatched tire and rim can cause an explosion.

INSPECT...

Before you put any tire on a rim, *inspect* the rim for rust, tough spots, bent edges, or cracks that could prevent the tire from seating right. If you spot any of these problems, don't mount the tire until the rim has been checked by your shop foreman.

Inspect the tire for bead damage.

MOUNT...

Once you've made sure the tire is OK and the right size and the rim is OK, *mount* the tire safely. NEVER, ever lean over the tire when you're inflating it. If a tire does explode, it will go straight up. You don't want to be over the tire if that happens. Also, never over-inflate the tire, even if the bead doesn't seat. Never inflate over 40 PSI. If the tire hasn't seated, something is wrong. Deflate the tire and check it and the rim again. If it doesn't work the second time, try another tire.

BE CAREFUL OF THESE SITUATIONS:

- | | | | |
|---|--|--|--|
| 1. Damaged Bead or Beads. | 4 A. Mismatched. (A mis-match of a 16-inch tire to a 16.5-inch rim causing an explosion) | 5. Walk-In Tire and Rim. | 8. Standing Clear. (Never put any part of your body over the tire changer during inflation.) |
| 2. Rusty Wheels. (particularly in the bead seat area) | 4 B. Mismatched. (16.5-inch tire on a 16-inch rim) | 6. Back Injuries. | 9. Beads will not Seat at 40 PSI. |
| 3. Bent or Cracked Wheels. | | 7. Hand or Finger Injuries. (Hands or fingers too close to inflating tire or bead seats which may cause injury.) | 10. Improper Inflation. |

Remember R.I.M. (*Read, Inspect, Mount*) for every tire.



FAILURE TO READ AND FOLLOW ALL WARNINGS AND INSTRUCTIONS IN THIS MANUAL CAN LEAD TO SERIOUS PERSONAL INJURY OR DEATH TO OPERATOR OR BYSTANDER.

THE OWNER IS RESPONSIBLE FOR MAINTAINING THE OPERATION INSTRUCTIONS AND DECALS FOR OPERATOR REFERENCE. FOR ADDITIONAL COPIES, CONTACT THE COATS® COMPANY, 1601 J.P. HENNESSY DRIVE, LAVERGNE, TENNESSEE, 37086 - (800) 688-6359.

TIRE FAILURE UNDER PRESSURE IS HAZARDOUS! This tire changer Will Not Restrain Exploding Tires, rims or other related equipment.

TIRES CAN EXPLODE, ESPECIALLY IF INFLATED BEYOND SPECIFIED LIMITS. DO NOT EXCEED TIRE MANUFACTURERS RECOMMENDED AIR PRESSURE.

AN EXPLODING TIRE, RIM, OR BEAD SEATING EQUIPMENT MAY PROPEL UPWARD AND OUTWARD WITH SUFFICIENT ENERGY TO CAUSE SERIOUS INJURY OR DEATH TO OPERATOR AND/OR BYSTANDERS.