

# COATS®

## 6275HS Wheel Balancer



### Installation Instructions Operating Instructions Safety Instructions Maintenance Instructions

READ these instructions before placing unit in service KEEP these and other materials delivered with the unit in a binder near the machine for ease of reference by supervisors and operators.

**HENNESSY INDUSTRIES, INC.**

1601 J. P. Hennessy Drive, LaVergne, TN USA 37086-3565 615/641-7533 800/688-6359 www.ammcoats.com

HENNESSY INDUSTRIES INC. Manufacturer of AMMCO®, COATS® and BADA® Automotive Service Equipment and Tools.

Manual Part No.: 85606351 00

Revision: 02/09



## CONTENTS

<b>1 - GENERAL</b>	<b>3</b>
1.1 - GENERAL SAFETY REGULATIONS	3
1.1.1 - STANDARD SAFETY DEVICES	3
1.2 - FIELD OF APPLICATION	3
1.3 - MAIN PARTS	3
1.4 - OVERALL DIMENSIONS	3
1.5 - TECHNICAL DATA	4
<b>2 - HANDLING, LIFTING</b>	<b>4</b>
2.1 - ANCHORING	4
<b>3 - START-UP</b>	<b>5</b>
3.1 - ELECTRICAL CONNECTION	5
3.2 - ADAPTER MOUNTING	5
3.3 - WHEEL MOUNTING	5
<b>4 - CONTROLS AND COMPONENTS</b>	<b>6</b>
4.1 - CONTROL PANEL AND DISPLAY	6
4.2 - AUTOMATIC DISTANCE AND DIAMETER GAUGE	6
4.3 - WHEEL LIFTING DEVICE	6
4.4 - MANUAL SPINNING DEVICE	6
<b>5 - INDICATIONS AND USE OF THE WHEEL BALANCER</b>	<b>7</b>
5.1 - DATA SETTING	7
5.2 - RESULT OF MEASUREMENT	8
5.2.1 - BATTERY CHARGE INDICATION (OPTION)	8
5.2.2 - MODIFYING SET DIMENSIONS	9
5.2.3 - EXACT POSITIONING OF THE ADHESIVE WEIGHT BY MEANS OF THE GAUGE WITH CLIPS	9
5.2.4 - SPLIT FUNCTION (HIDDEN ADHESIVE WEIGHTS)	10
5.2.5 - UNBALANCE OPTIMIZATION	11
5.2.6 - ALU AND STATIC MODES	11
5.2.7 - AUTOMATIC MINIMIZATION OF STATIC UNBALANCE	11
<b>6 - SET UP</b>	<b>12</b>
6.1 - MENU	12
6.2 - AUTOMATIC GAUGES CALIBRATION	13
6.2.1 - RIM DISTANCE GAUGE	13
6.2.2 - DIAMETER GAUGE	13
6.3 - BALANCING MACHINE CALIBRATION	14
<b>7 - ERRORS</b>	<b>15</b>
7.1 - INCONSISTENT UNBALANCE READINGS	16
<b>8 - ROUTINE MAINTENANCE (SEE EXPLODED DRAWINGS)</b>	<b>16</b>
8.1 - TO REPLACE THE FUSES	16
8.2 - PRECAUTIONS FOR BATTERY USE	16



## 1 - GENERAL

### ► 1.1 - GENERAL SAFETY REGULATIONS

- The machine should only be used by authorized and suitably trained personnel.
- Do not use the machine for purposes other than those specified in this manual.
- The machine should not be modified in any way except for those modifications explicitly carried out by the firm.
- Never remove the safety devices. Any work on the machine should only be carried out by specialist personnel.
- Carefully clean the coupling surfaces before performing any operation.
- Avoid using strong jets of compressed air for cleaning.
- Use alcohol to clean the plastic panel or shelves (AVOID LIQUIDS CONTAINING SOLVENTS).
- Before starting the wheel balancing cycle, make sure that the wheel is securely locked on the adapter.
- The machine operator should avoid wearing clothes with flapping edges. Make sure that unauthorized personnel do not approach the machine during the work cycle.
- Avoid placing objects inside the base as they could impair the correct operation of the machine.

#### ► 1.1.1 - STANDARD SAFETY DEVICES

- The wheel guard is not compulsory since the balancing speed is less than 100 rpm.

### ► 1.2 - FIELD OF APPLICATION

The machine is designed for balancing wheels of cars and motor vehicles weighing up to 250 kg. It can be operated in the temperature range of 0°C/32°F to + 45°C/113°F.

The following functions are provided: ALUM, SPLIT; Unbalance optimization; Self diagnostics; Self calibration.

### ► 1.3 - MAIN PARTS

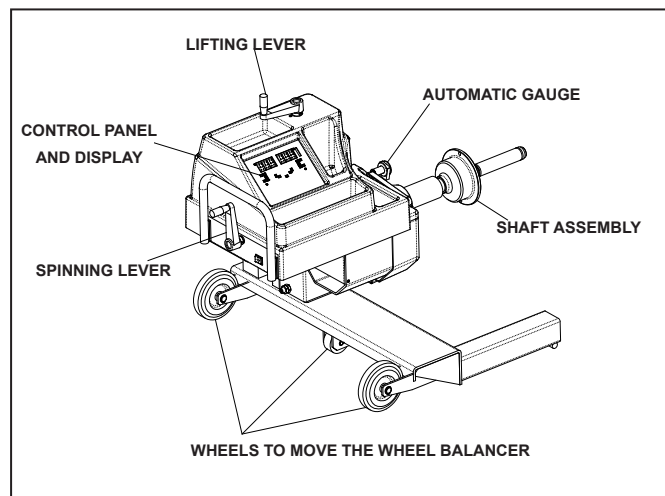

### ► 1.4 - OVERALL DIMENSIONS

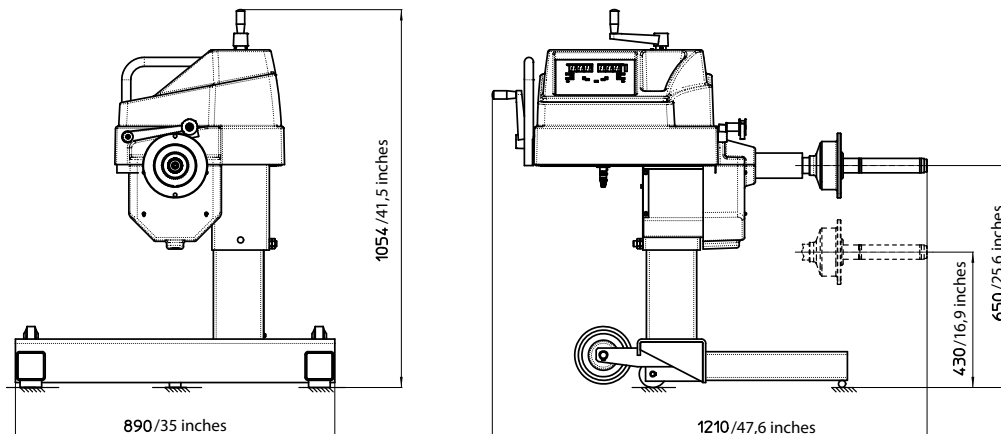

## ► 1.5 - TECHNICAL DATA

Single-phase power supply	12 - 24 V DC 0,15 A
Protection class	IP 54
Balancing speed	70 rpm TRUCK
Balancing speed	100 rpm CAR
Cycle time	8-20 seconds
Balancing accuracy	1 gram/0,1.oz (car) - 10 grams/0,5.oz (truck)
Position resolution	± 0.7°
Average noise	< 70dB (A)
Rim-machine distance	0 - 300 mm / 0 - 11,8 inches
Rim width setting range	1.5" ÷ 20" or 40 ÷ 510 mm
Diameter setting range	10" ÷ 30" or 265 ÷ 765 mm
Max. wheel diameter	1300 mm / 51,2 inches

## 2 - HANDLING, LIFTING

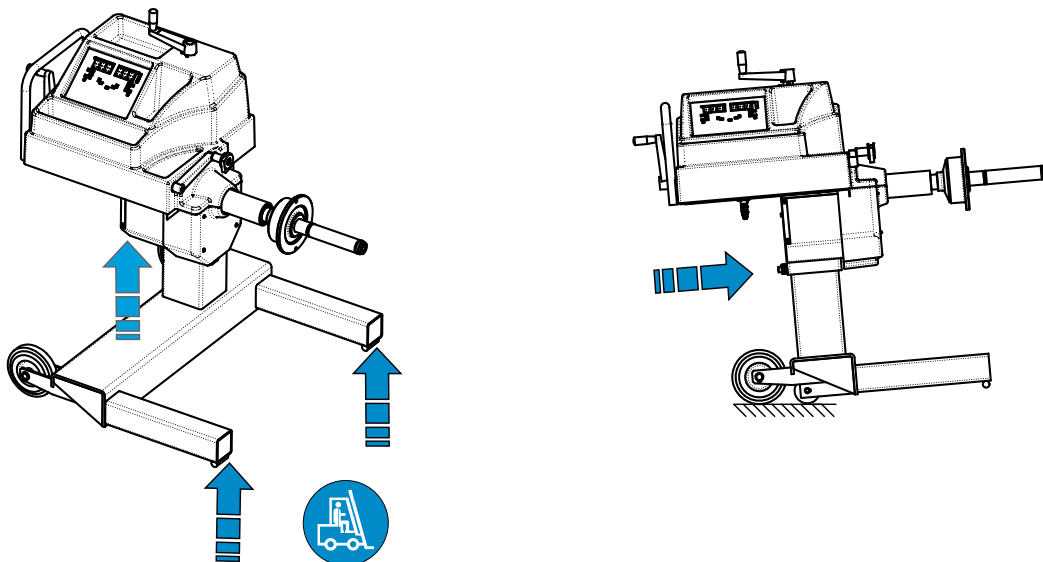

**THE WHEEL BALANCER MUST BE MOVED USING THE HANDLE AND THE WHEELS AND RAISED BY PRISING ON THE BASE ONLY AT THE THREE POINTS INDICATED.**

**NEVER, UNDER ANY CIRCUMSTANCE, APPLY FORCE TO OTHER POINTS SUCH AS THE SPINDLE, HEAD, OR ACCESSORY SHELF.**

## ► 2.1 - ANCHORING

The machine can operate on any flat non resilient floor without having to be anchored to the floor. Make sure that the machine rests on the 3 mounting points provided.

## 3 - START- UP

### ▶ 3.1 - ELECTRICAL CONNECTION

The machine is supplied with an AC power supply and power cable with 12-24 VDC battery. The supply voltage is given on the machine nameplate. It cannot be changed.

Connection to mains should always be made by expert personnel.

### ▶ 3.2 - ADAPTER MOUNTING

3

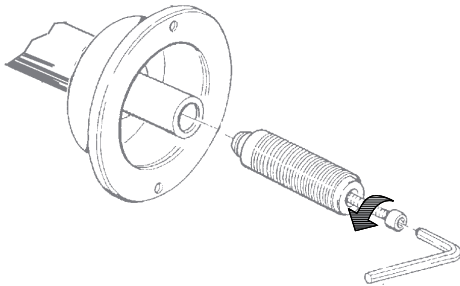

- ▶ The wheel balancer is supplied complete with cone type adapter for fastening wheels with central bore. The threaded terminal is fitted according to the drawing; it can be removed to fit optional adapters.

### ▶ 3.3 - WHEEL MOUNTING

The wheels should be fastened with one of the numerous adapters available.

***Incorrect centering inevitably causes unbalance.***

## 4 - CONTROLS AND COMPONENTS

### ► 4.1 - CONTROL PANEL AND DISPLAY

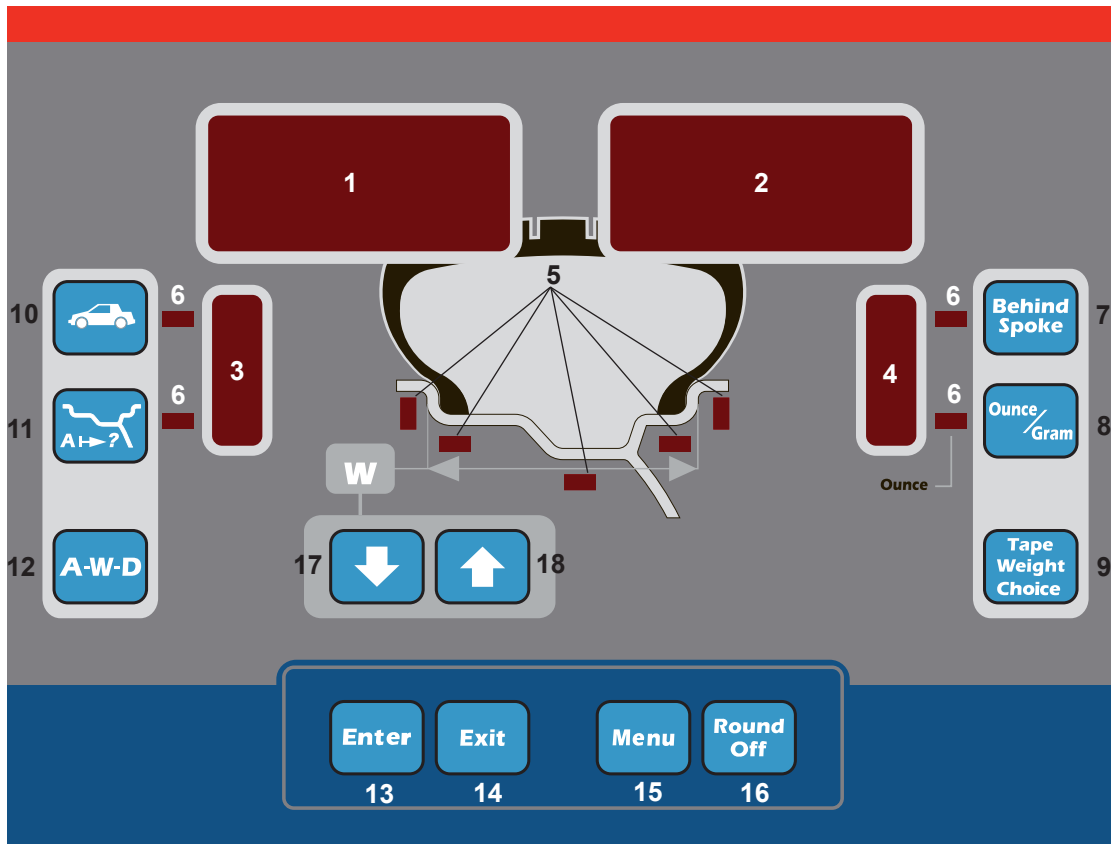

1-2	Digital readouts, AMOUNT OF UNBALANCE, inside/outside	10	Push button, car/truck selection
3-4	Digital readouts, POSITION OF UNBALANCE, inside/outside	11	Position repeat
5	Indicators, correction mode selected	12	Push buttons, manual dimensions setting
6	Indicators, selection made	13	Push button, menu selection confirmation
7	SPLIT push button (unbalance resolution)	14	EXIT/emergency push button
8	Push button, ounces/grams selection	15	Push button, FUNCTIONS MENU
9	Push button, selection of mode of correction	16	Push button, unbalance reading < 5 g (0.25 oz)
		17	Minimize/MENU button
		18	Maximize/MENU button



- **ONLY USE THE FINGERS TO PRESS THE PUSH BUTTONS.**
- **NEVER USE THE COUNTERWEIGHT PINCERS OR OTHER POINTED OBJECTS.**

### ► 4.2 - AUTOMATIC DISTANCE AND DIAMETER GAUGE

This gauge allows measurement of the distance of the wheel from the machine and the wheel diameter at the point of application of the counterweight. It also allows correct positioning of the counterweights on the inside by using the specific function (see **INDICATION OF EXACT CORRECTION WEIGHT POSITION**) which allows reading the position used for the measurement within the rim.

### ► 4.3 - WHEEL LIFTING LEVER

Allows lifting the wheel from the ground without using a lift in order to spin it. It also allows lowering the wheel until it touches the ground in order to stop rotation.

### ► 4.4 - MANUAL SPINNING LEVER

Allows spinning the tyre. When the machine display turns off, it means that the minimum spindle rotation speed has been reached to perform correct balancing (70 rpm. for trucks and 100 rpm. for cars). At this point, release the handle and wait until the unbalance measured appears on the display. If the beep function is enabled (see **MENU**), a beep will sound when the correct balancing speed is reached.

## 5 - USE OF THE WHEEL BALANCER

### ► 5.1 - DATA SETTING

Press the button  ; LED on   → balancing machine set in car mode

The balancing data is set by means of an "intelligent" automatic gauge; confirmation of the measurement and the position appear on the display. The round part of the gauge must rest on the rim where the weight will be positioned.

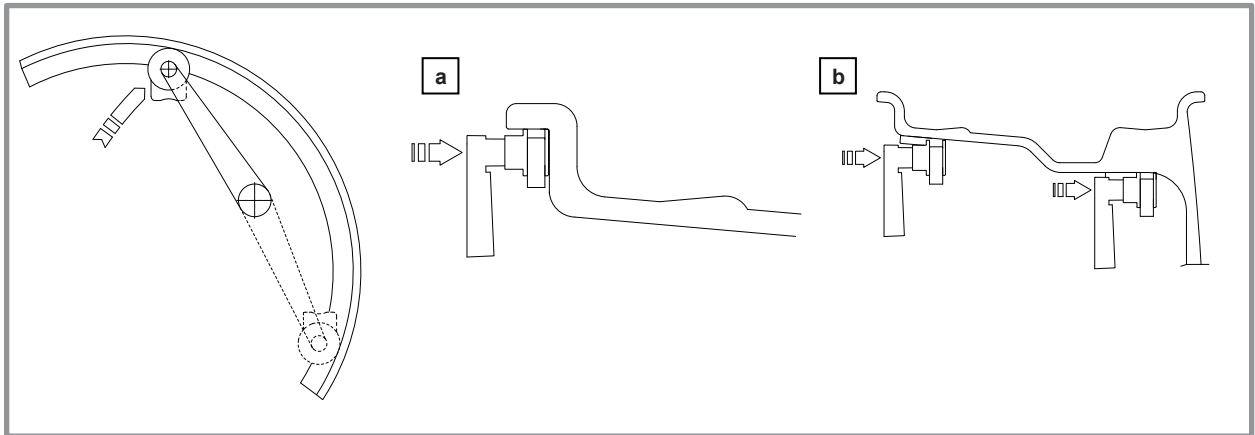

While the gauge is moving the following appears   ;

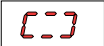
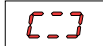
when the measurement has been stored   .

**a) standard weights:** When only one measurement is made, the machine interprets the presence of a rim with clip-on weight correction



The width value ( $W$ ) must be set with the buttons   . The correct measurement is that which can be measured with the compass gauge provided.

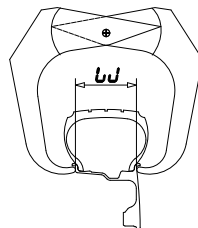

**b) adhesive weights:** Make two successive measurements on two correction planes inside the rim.

The balancing machine automatically interprets that the correction will be made with adhesive weights and the following appears:



For a different combination of the type or position of the weights on the rim, use the button .



► **5.2 - RESULT OF MEASUREMENT**

► **Unbalance display pitch:**

Car = 1/5 g (0.1/0.25 Oz)    Truck = 10/50 g (.25/1 Oz)

When  is pressed, the unbalance is displayed with pitch:



Car =    1 g                      Truck = 10 g  
           0.1 Oz                      0.25 Oz

► **Unbalance display threshold**

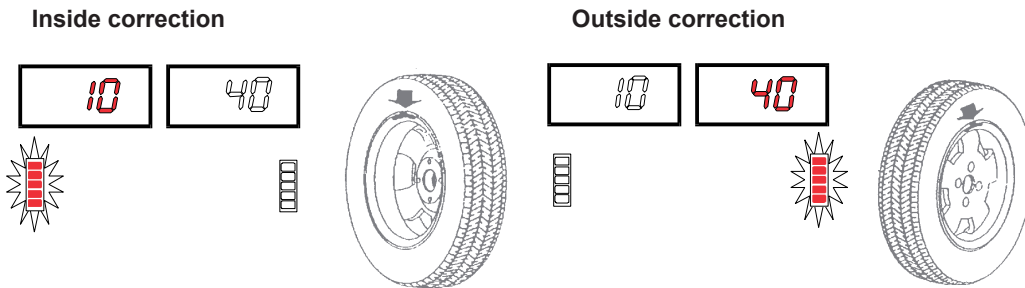
Car = 5 g (0.4 Oz)                      Truck = 50 g (2 Oz)





After performing a balancing spin, the amounts of unbalance are shown on the digital readouts. Digital readouts with LED's 3- 4 lit up indicate the correct angular wheel position to mount the counterweights (12 o'clock position).

If the unbalance is less than the threshold selected  is displayed instead of the unbalance. With  it is possible to read the values below the threshold chosen.









**NOTE:** For wheel diameters less than or equal to 13" and at temperatures around 0° C/32° F, the wheel balancer automatically initiates a special measurement cycle involving two consecutive measurements. The precision of unbalance values and the reliability of the wheel balancer are unaffected. If

the mobile symbol  should appear at the end of any balancing start operation, turn the wheel by hand until the unbalance values are displayed. If the battery is low, the symbol   will appear on the screen.

► **5.2.1 - BATTERY CHARGE INDICATION (OPTION)**

Displays the battery charge.

To access the function, see **MENU MANAGEMENT**

		Battery low
		Battery 50% charged
		Battery fully charged or with 12V power supply

► 5.2.2 - MODIFYING SET DIMENSIONS

If the wheel dimensions have been entered incorrectly, the parameters can be modified without repeating the balancing spin by pressing :

 access parameter modification →



(select   to modify: ( $R$ ) distance, ( $W$ ) width, ( $d$ ) diameter

→  to obtain the new measurement

or:

pull out the gauge to repeat the measurement →  to obtain the new measurement.



► 5.2.3 - EXACT POSITIONING OF THE ADHESIVE WEIGHT BY MEANS OF THE GAUGE WITH CLIPS

Press the button   if using the correction method with weights on the inside of the rim.









- Fit the correction weight in the specific gauge seat with the adhesive part facing upwards
- Bring the wheel into correct angular position for the plane to be corrected.
- Pull the gauge further outwards.
- Return the gauge to the rest position.

- INSIDE CORRECTION POSITION





- OUTSIDE CORRECTION POSITION

- When the weight application distance has been reached a beep is sounded (can be deactivated).
- rotate the gauge until the correction weight adheres to the rim
- the fact that the weight application position is no longer vertical is automatically compensated
- to cancel this function, press  button again.

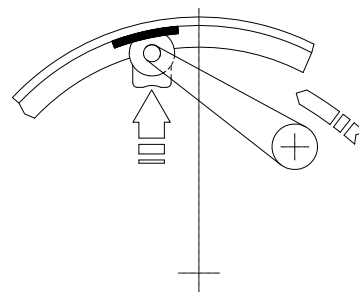
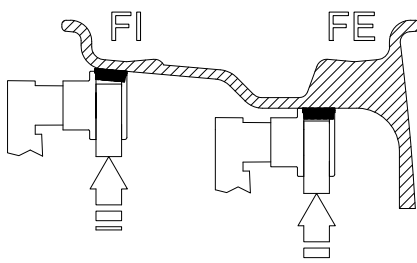

### ► 5.2.4 - SPLIT FUNCTION (UNBALANCE RESOLUTION)

The SPLIT function is used to position the adhesive weights behind the wheel spokes so that they are not visible. This function should be used in ALU mode where the adhesive weight is applied on the outside. Input the wheel dimensions and do a spin.

	27	25	<ul style="list-style-type: none"> <li>Turn the wheel to the outside unbalance correction position as indicated by the machine</li> </ul>
	27		<ul style="list-style-type: none"> <li>Position one spoke at 12 o'clock (e.g. 1) and press </li> </ul>
	27		<ul style="list-style-type: none"> <li>Following the rotation direction indicated on the display, position spoke 2 at 12 o'clock and press </li> </ul>
	27	10	<ul style="list-style-type: none"> <li>Position the wheel as indicated by the LEDs. The unbalance is indicated on the right-hand display</li> </ul>
	27	20	<ul style="list-style-type: none"> <li>Repeat the operation for the other spoke</li> </ul>

To return to normal unbalance display, press any button.



**NOTE:** The distance between the spokes must be at least 18° and at most 120° (if not, the errors 24,25 or 26 appear). Spokes with irregular or inconstant angles can be compensated.

### ► 5.2.5 - UNBALANCE OPTIMIZATION

- This function serves to reduce the amount of weight to be added in order to balance the wheel.
- It is suitable for static unbalance exceeding 30 g./ 1.5 .oz
- It improves the residual eccentricity of the tyre.

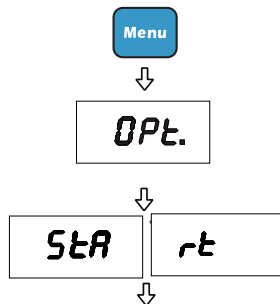

This operation is required if no unbalance has been measured previously; otherwise go to the next step

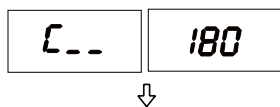

- Mark with chalk a reference point on the adapter and rim.
- With the aid of a tyre remover, turn the tyre on the rim by 180°.
- Refit the wheel with the reference mark coinciding between rim and adapter.



- RH display: percentage reduction
- LH display: actual static unbalance which can be reduced by rotation.

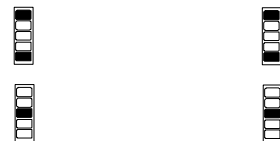

- Mark the two positions of the rim and tyre, and turn the tyre on the rim until the positions correspond in order to obtain the optimization on the display.



- **RETURN TO MEASUREMENT SCREEN.**

### ► 5.2.6 - ALU AND STATIC MODES

From the measurement screen, press the  button to select all the possible types of corrections. The (5)-LED

displays show the position where to apply the weights. If a spin has already been performed, the processor automatically recalculates, for each change of mode, the amounts of unbalance according to the new calculation.

### ► 5.2.7 - AUTOMATIC MINIMIZATION OF STATIC UNBALANCE

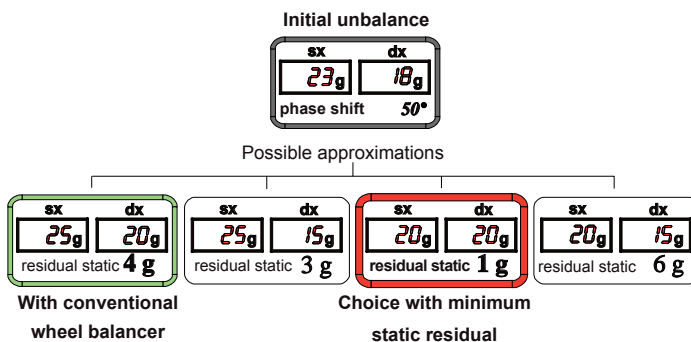

This program is designed to improve the quality of balancing without any mental effort or loss of time by the operator. In fact by using the normal commercially available weights, with pitch of 5 in every 5 g, and by applying the two counterweights which a conventional wheel balancer rounds to the nearest value, there could be a residual static unbalance of up to 4 g. The damage of such approximation is emphasized by the fact that static unbalance is cause of most of disturbances on the vehicle. This new function automatically indicates the optimum entity of the weights to be applied by approximating them in an "intelligent" way according to their position in order to minimize residual static unbalance.

## 6 - SET UP

### ► 6.1 - MENU

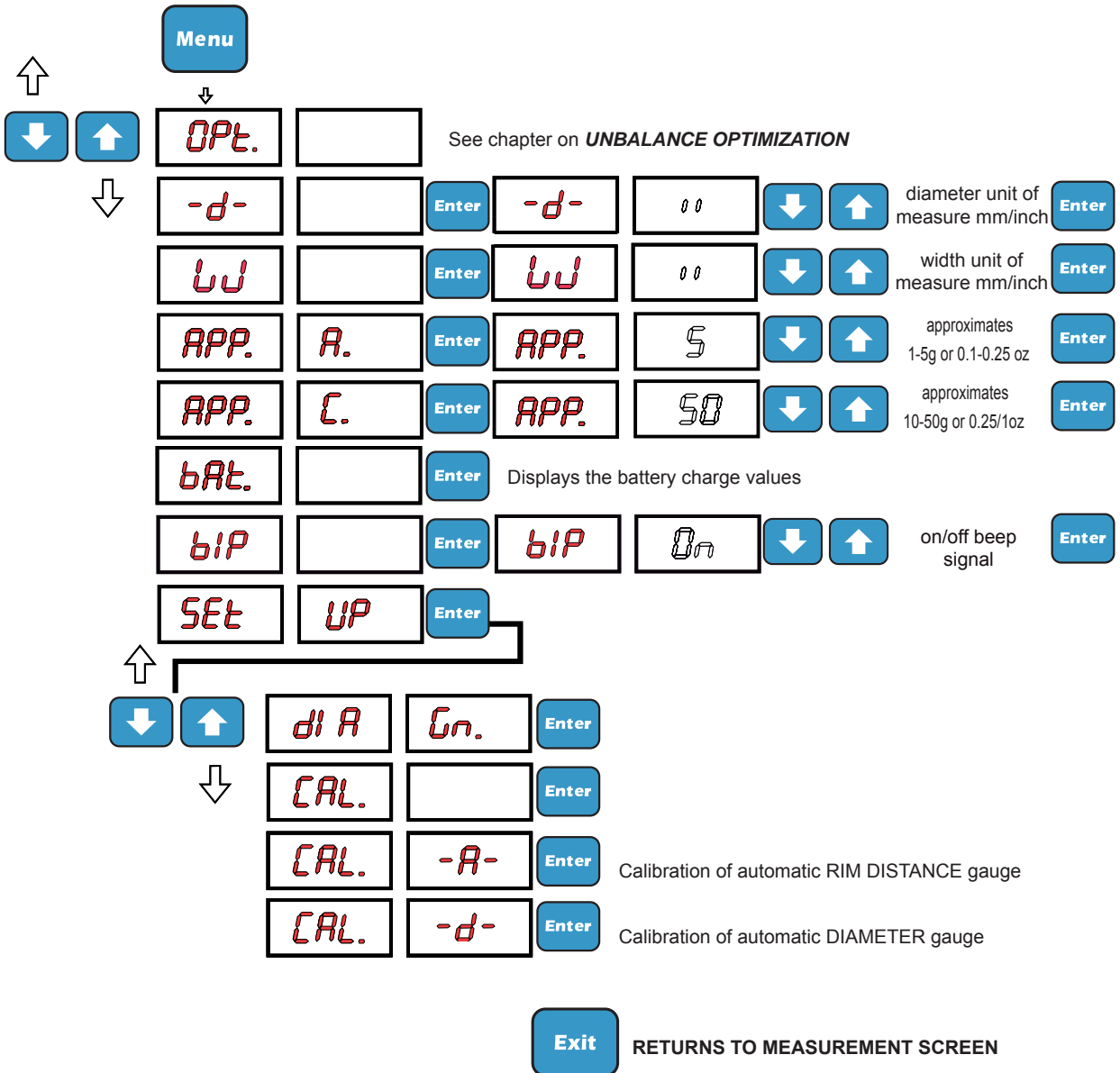

## ► 6.2 - AUTOMATIC GAUGES CALIBRATION

### ► 6.2.1 - RIM DISTANCE GAUGE



Enter



- Leave the distance gauge in rest position and press **Enter**



- Pull out the gauge up to the adapter flange and press **Enter**



- **CORRECT CALIBRATION**  
Return the gauge to rest position.  
The wheel balancer is ready for operation.

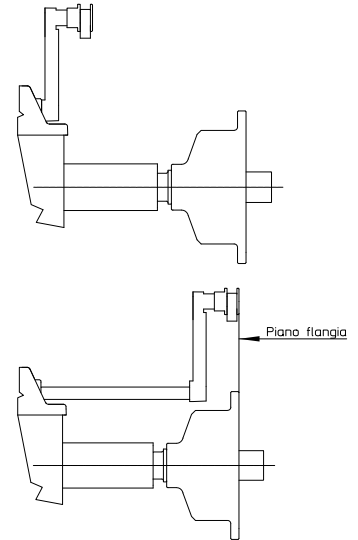

**NOTE.:** In the event of errors or faulty operation, the writing **"r.P."** appears on the display : shift the gauge to the rest position and repeat the calibration operation exactly as described above. If the error persists, contact the Technical Service Department. In the event of incorrect input in the rim

distance gauge calibration function, press **Exit** to cancel it.

### ► 6.2.2 - DIAMETER GAUGE



Enter

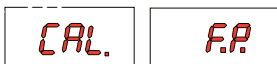

- Place the round part of the gauge terminal on the flange as shown in the figure and press **Enter**



- The number  $8 \pm 3^\circ$  appears on the left display .

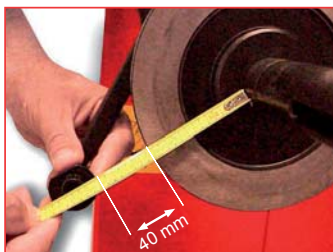

- Turn the gauge downward position the round part of the gauge terminal at 40 mm (radial distance) from the flange as indicated in the figure; alternatively use one of the cones provided as shown in the images



- The number  $289 \pm 3^\circ$  should appear on the left display. The calibration is already correct.
- If not, press the **Enter** button holding the gauge still at 40 mm: the number 289 appears on the left display.
- Return the gauge to rest position.

### ► 6.3 - BALANCING MACHINE CALIBRATION

To calibrate the machine, operate as follows:

- Fit a medium-sized wheel with steel rim on the shaft. Example: 6" x 15" ( $\pm 1$ " best with less than 20 g unbalance
- Take the exact measurements of the wheel mounted as described in **DATA SETTING**.



**PRESETTING OF INCORRECT DIMENSIONS WOULD MEAN THAT THE MACHINE IS NOT CORRECTLY CALIBRATED, THEREFORE ALL SUBSEQUENT MEASUREMENTS WILL BE INCORRECT UNTIL A NEW SELF-CALIBRATION IS PERFORMED WITH THE CORRECT DIMENSIONS!**

CAL. [ ]

Enter

↓  
StA rt

- Perform a manual spin under normal conditions

↓  
Add. 60

- Add a sample weight on the outside in any angular position.  
Sample weight: 60 g. (2.00 .oz) for car  
300 g. (10.0 .oz) for truck
- Perform a manual spin

↓  
60 Add.

- Shift the sample weight from the outside to the inside keeping the same angular position.
- Perform a manual spin

↓  
r07 [ ]

- Turn the wheel until the sample weight is in the 12 o'clock position

Enter

↓  
CAL. [ ]

- END OF CALIBRATION

Exit

- CANCELS CALIBRATION IN ANY PHASE.

## 7 - ERRORS

During machine operation, various causes of faulty operation could occur. If detected by the microprocessor, they appear on the display as follows:



ERRORS	CAUSES	CONTROLS
Black	The wheel balancer does not come on.	<ol style="list-style-type: none"> <li>1. Check proper connection to the mains.</li> <li>2. Check and if necessary replace the fuses on the power board.</li> <li>3. Replace the computer board.</li> </ol>
Err. 1	No rotation signal.	<ol style="list-style-type: none"> <li>1. Check belt tautness.</li> <li>2. Check in self-diagnostics that the encoder functions properly.</li> <li>3. Replace the phase generator.</li> <li>4. Replace the computer board.</li> </ol>
Err. 2	Too low speed during measurement. During the unbalance measurement revolutions, the wheel speed has fallen to below 42 rpm.	<ol style="list-style-type: none"> <li>1. Check that a vehicle wheel has been mounted on the wheel balancer.</li> <li>2. Check belt tautness.</li> <li>3. Check in self-diagnostics that the encoder functions properly.</li> <li>4. Detach the measuring head connector from the board and do a spin (if no error is detected, replace the measuring heads).</li> <li>5. Replace the computer board.</li> </ol>
Err. 3	Too high unbalance.	<ol style="list-style-type: none"> <li>1. Check the wheel dimension setting.</li> <li>2. Check the sensor connections.</li> <li>3. Run the machine calibration function.</li> <li>4. Mount a wheel with an approximately known unbalance (less than 100 grams) and check the machine response.</li> <li>5. Replace the computer board.</li> </ol>
Err. 4	Rotation in opposite direction. After pressing [START], the wheel starts turning in the opposite direction (anticlockwise).	<ol style="list-style-type: none"> <li>1. Verify the connection of the UP/DOWN - RESET signals on the phase encoder.</li> <li>2. Check the bearing/spring of the phase generator</li> </ol>
Err. 7 / Err. 8 / Err. 9	NOVRAM parameter read error	<ol style="list-style-type: none"> <li>1. Repeat machine calibration</li> <li>2. Shut down the machine.</li> <li>3. Wait for at least ~ 1 min.</li> <li>4. Restart the machine and check proper functioning.</li> <li>5. Replace the computer board.</li> </ol>
Err.14/ Err.15/ Err.16/ Err.17/ Err. 18/ Err. 19	Unbalance measurement error.	<ol style="list-style-type: none"> <li>1. Check functioning of the phase generator.</li> <li>2. Check the sensor connections.</li> <li>3. Check the machine earthing connection.</li> <li>4. Mount a wheel with an approximately known unbalance (less than 100 grams) and check the machine response.</li> <li>5. Replace the computer board.</li> </ol>
Err.22	Maximum number of spins possible for the unbalance measurement has been exceeded.	<ol style="list-style-type: none"> <li>1. Check that a vehicle wheel has been mounted on the wheel balancer.</li> <li>2. Check belt tautness.</li> <li>3. Check in self-diagnostics that the encoder functions properly</li> <li>4. Replace the computer board.</li> </ol>
Err. 23	The wheel does not slow down	<ol style="list-style-type: none"> <li>1. Remember to release the spinning device when the displays go off</li> <li>2. Check functioning of the phase generator.</li> <li>3. Replace the computer board.</li> </ol>
Err. 24	Distance between the spokes smaller than 18 degrees.	<ol style="list-style-type: none"> <li>1. The minimum distance between the spokes where to split the unbalance must be greater than 18 degrees</li> <li>2. Repeat the SPLIT function increasing the distance between the spokes.</li> </ol>
Err. 25	Distance between the spokes greater than 120 degree	<ol style="list-style-type: none"> <li>1. The minimum distance between the spokes where to split the unbalance must be smaller than 120 degrees</li> <li>2. Repeat the SPLIT function increasing the distance between the spokes.</li> </ol>
Err. 26	First spoke too far from unbalance position	<ol style="list-style-type: none"> <li>1. The minimum distance between the unbalance position and the spoke must be less than 120 degrees.</li> <li>2. Repeat the split function reducing the distance between the spokes.</li> </ol>
-	Battery low	<ol style="list-style-type: none"> <li>1. Recharge the battery</li> </ol>



► **7.1 - INCONSISTENT UNBALANCE READINGS**

Sometimes after balancing a wheel and removing it from the balancing machine, it is found that, upon mounting it on the machine again, the wheel is not balanced. This does not depend on incorrect indication of the machine, but only on faulty mounting of the wheel on the adapter; i.e. in the two mountings, the wheel has assumed a different position with respect to the balancing machine shaft centre line. If the wheel has been mounted on the adapter with screws, it could be possible that the screws have not been correctly tightened, i.e. crosswise one by one, or else (as often occurs) holes have been drilled on the wheel with too wide tolerances. Small errors, up to 10 grams (0.4 oz) are to be considered normal in wheels locked by a cone; the error is normally greater for wheels fastened with screws or studs.

If, after balancing, the wheel is found to be still out-of-balance when refitted on the vehicle, this could be due to the unbalance of the car brake drum or very often due to the holes for the screws on the rim and drum sometimes drilled with too wide tolerances. In such case a readjustment could be advisable using the balancing machine with the wheel mounted.

**8 - ROUTINE MAINTENANCE - see exploded drawings**

**For non specialized personnel only**

Disconnect the machine from the mains before carrying out any operation.

► **8.1 - TO REPLACE THE FUSES**

Remove the weight holder shelf to gain access to the power supply board where the fuses are located (see Exploded Drawings). If fuses require replacements, use new ones of the same current rating.

If the fault persists, contact the Technical Service Department.

► **8.2 - PRECAUTIONS FOR BATTERY USE**

To keep the battery efficient over time, do not expose it to direct sunlight, avoid contact with liquids and do not connect the output in short-circuit.

**NONE OF THE OTHER MACHINE PARTS REQUIRE MAINTENANCE.**

